

03 | ANSCHLAGPROFILE

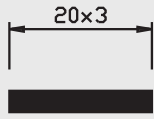

Nr. 10/44 H

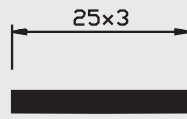

Nr. 10/43 H

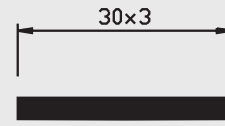

Nr. 10/42 H

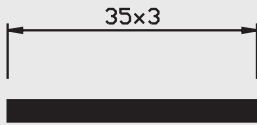

Nr. 10/41 H

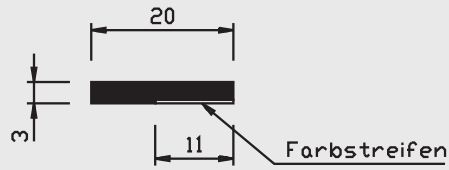

Nr. 20/44 H
zweifarbig

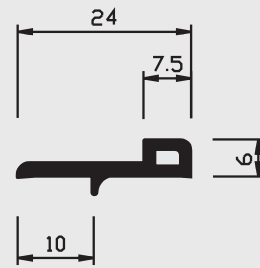

Nr. 14/43 H

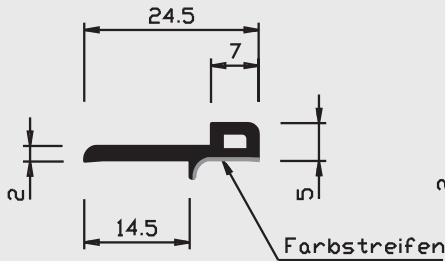

Nr. 20/43 H
zweifarbig

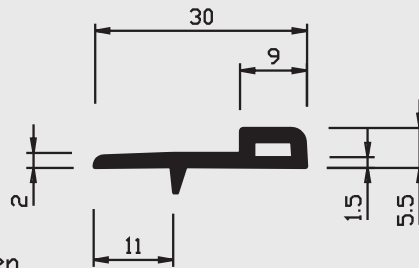

Nr. 16/43 H

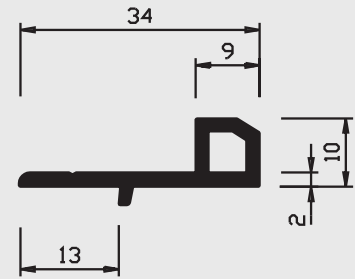

Nr. 18/43 H

= Hart PVC
 = Weich PVC | HH = Halbhart PVC
 = Andere Kunststoffe

03 | ANSCHLAGPROFILE

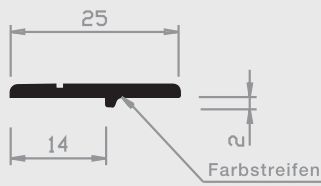

Nr. 11/43 H
zweifarbig

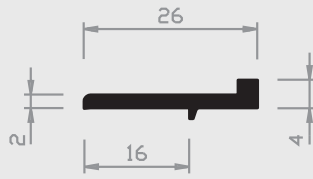

Nr. 15/43 H

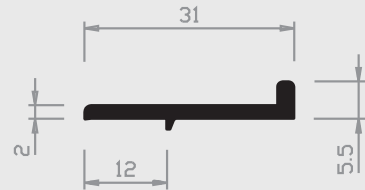

Nr. 16/42 H

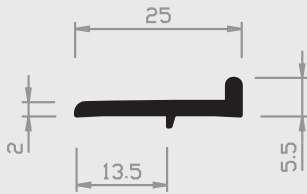

Nr. 20/43a H 5,5mm

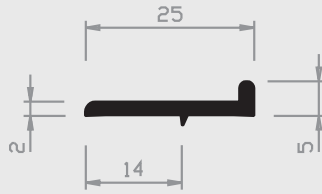

Nr. 20/43b H 5mm

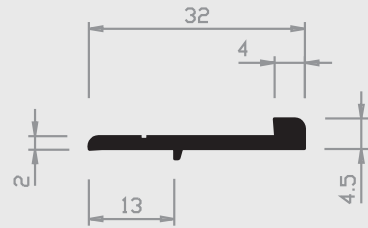

Nr. 17/42 H

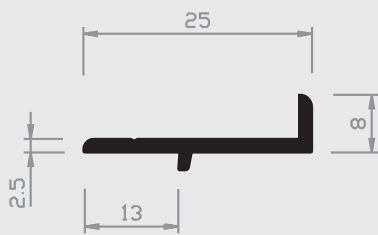

Nr. 17/43 H

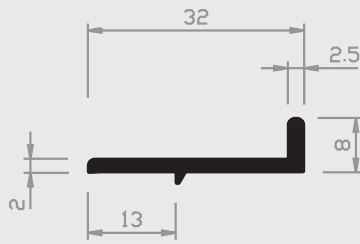

Nr. 22/43 H 8mm

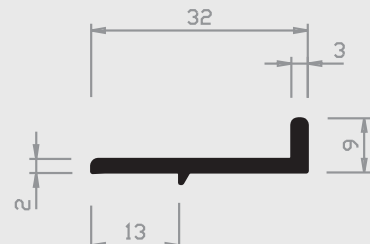

Nr. 22/43a H 9mm

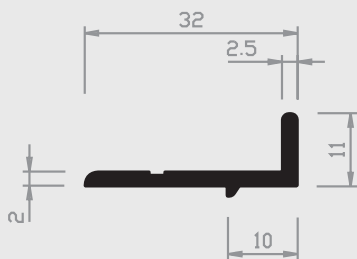

Nr. 22/44 H

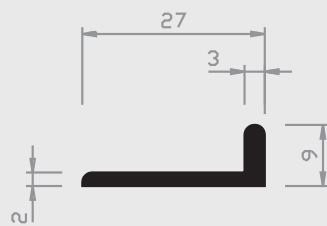

Nr. 22/43 H

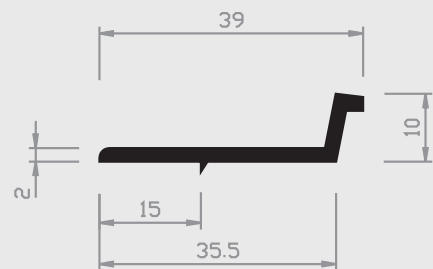

Nr. 21/41 H

= Hart PVC
 = Weich PVC | HH = Halbhart PVC
 = Andere Kunststoffe

03 | ANSCHLAGPROFILE

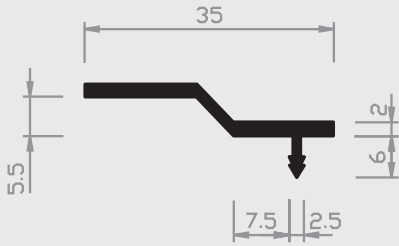

Nr. 21/40 H

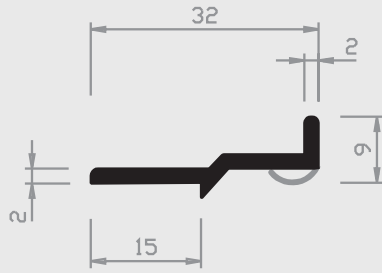

Nr. 24/43 H+W

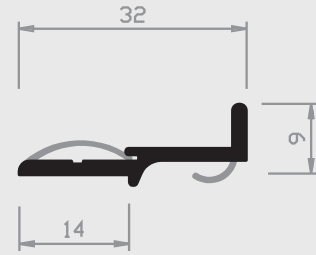

Nr. 24/43a H+W 9mm

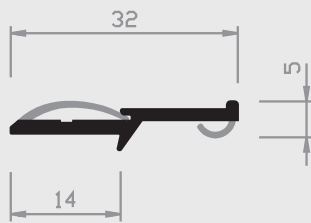

Nr. 24/43b H+W 5mm

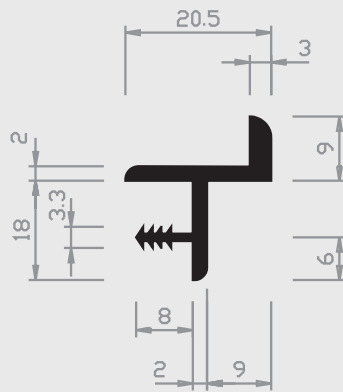

Nr. 21/43 H

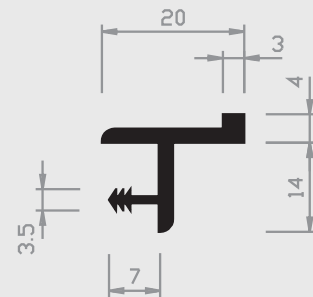

Nr. 21/43a H

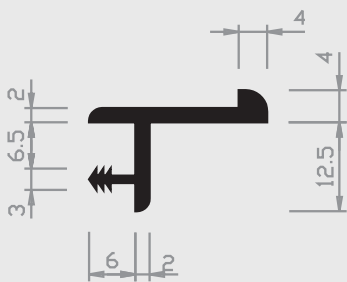

Nr. 28/43 H

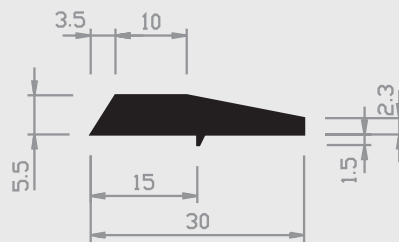

Nr. 25/43 H



Nr. 20/43a H

■ = Hart PVC

■ = Weich PVC | HH = Halbhart PVC

□ = Andere Kunststoffe

03 | ANSCHLAGPROFILE

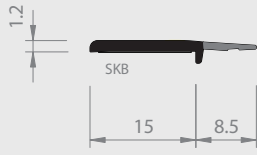

Nr.22/42 H+W
selbstklebend

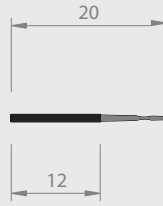

Nr.21/42a H+W 20 mm

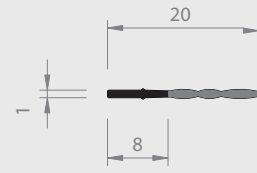

Nr.21/42b H+W



Nr.23/42 H+W

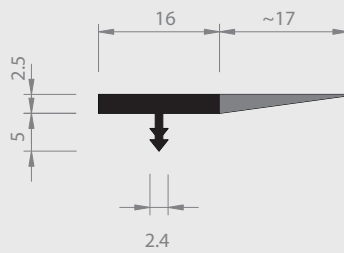

Nr.24/42 H+W

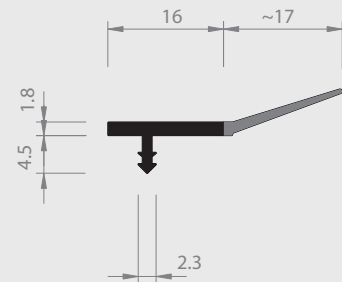

Nr.25/41 H+W

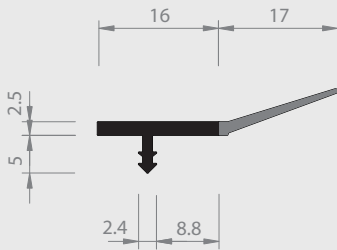

Nr.25/42 H+W

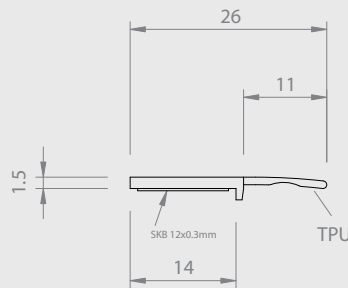

Nr. 22/39 ABS/TPU

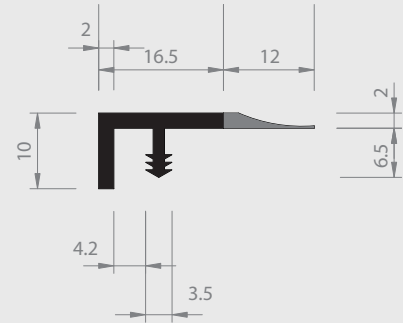

Nr.26/42 H+W

■ = Hart PVC

■ = Weich PVC | HH = Halbhart PVC

□ = Andere Kunststoffe

03 | ANSCHLAGPROFILE

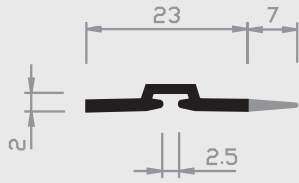

Nr. 19/42 H+W

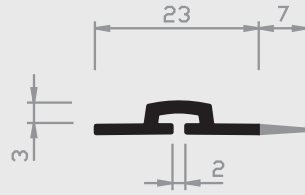

Nr. 20/45 H+W

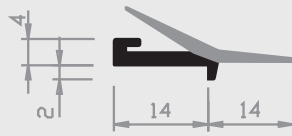

Nr. 27/42 H+W

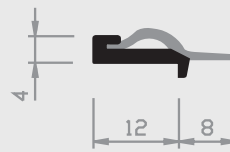

Nr. 20/45 H+W

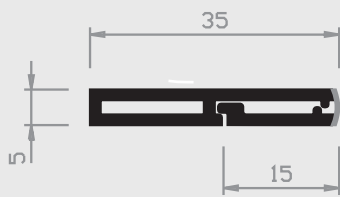

Nr. 27/43 H+W

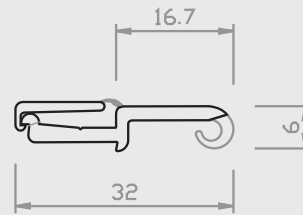

Nr. 31/43 ABS/TPU

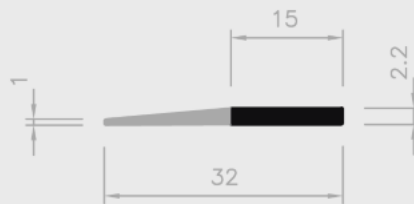

Nr. 24/42a H+W

= Hart PVC
 = Weich PVC | HH = Halbhart PVC
 = Andere Kunststoffe

03 | ANSCHLAGPROFILE

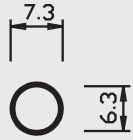

Überzugsrohr für
Drehriegelschloß

Nr. 50/32 H

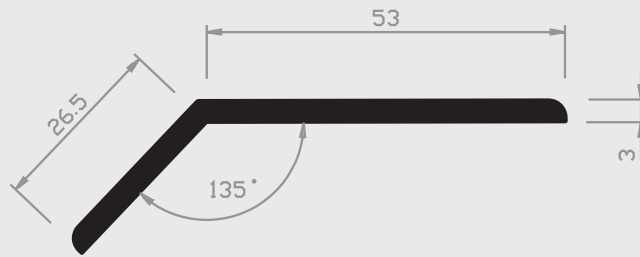

Nr. 11/18 H

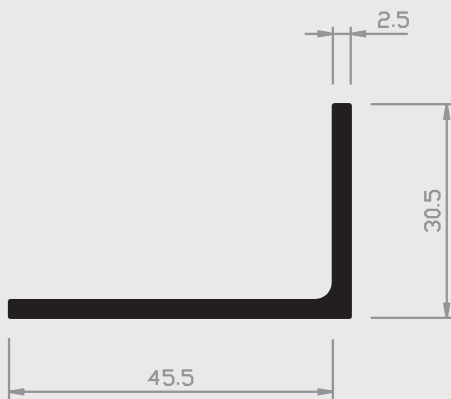

Nr. 16/63 H

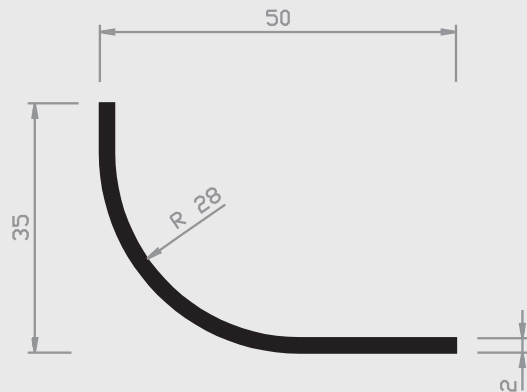

Nr. 11/17 H

■ = Hart PVC ■ = Weich PVC | HH = Halbhart PVC □ = Andere Kunststoffe

03 | ANSCHLAGPROFILE



Nr. 11/17a H

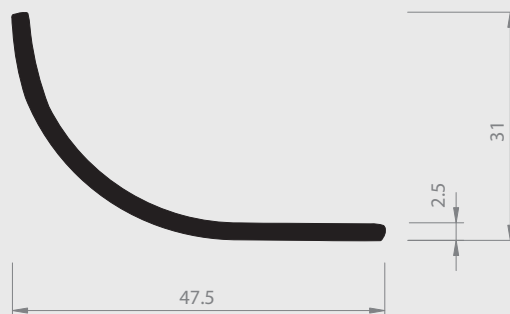

Nr. 11/17b H

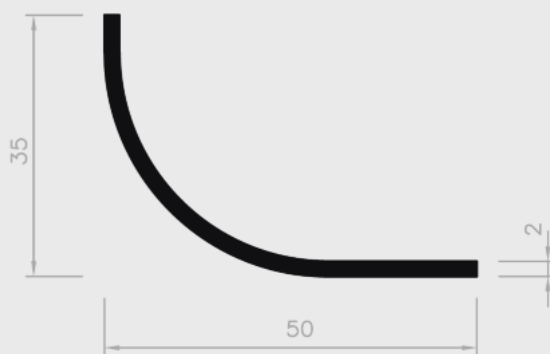

Nr. 11/17 H

■ = Hart PVC ■ = Weich PVC | HH = Halbhart PVC □ = Andere Kunststoffe