

07 | GLEITPROFILE

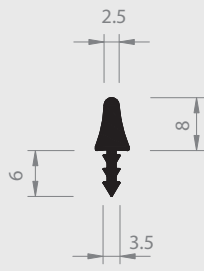

Nr.10/30 H

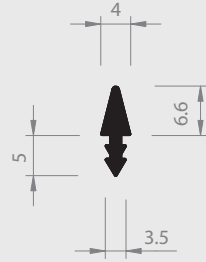

Nr.12/30 H

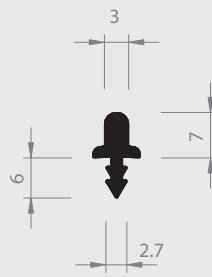

Nr.11/30 H

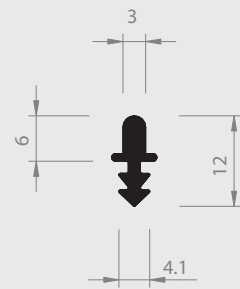

Nr. 25/30 H

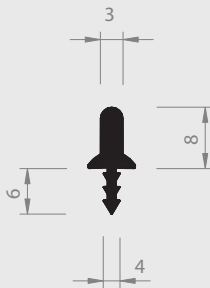

Nr.13/30 H

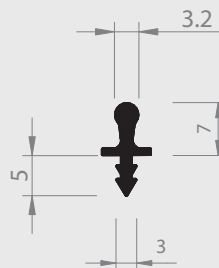

Nr.16/30 H

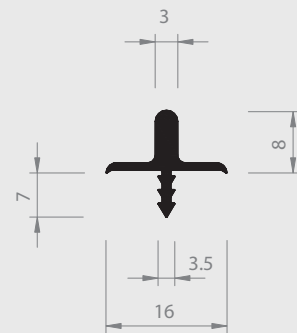

Nr.14/30 H

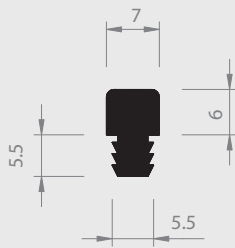

Nr.15/30 H

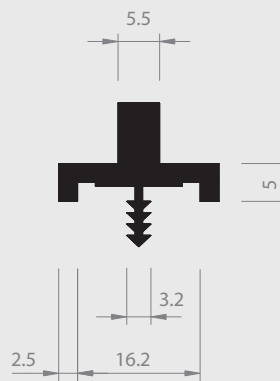

Nr.18/30 H

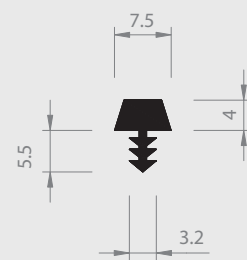

Nr.17/30 H

= Hart PVC
 = Weich PVC | HH = Halbhart PVC
 = Andere Kunststoffe

07 | GLEITPROFILE

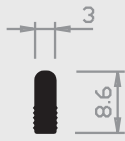

Nr. 9/28 H



Nr. 8/28 H

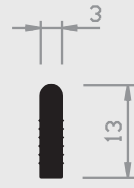

Nr. 10/28 H

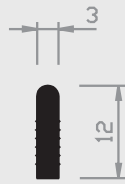

Nr. 11/28 H



Nr. 12/28 H

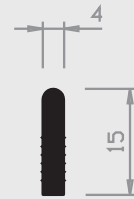

Nr. 13/28 H

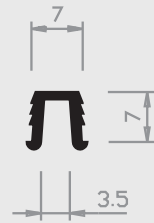

Nr. 9/24 H

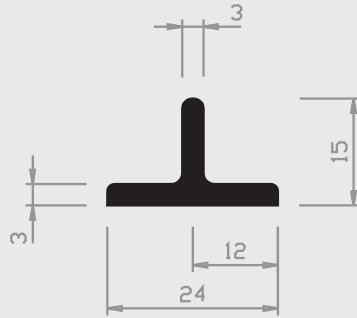

Nr. 15/29 H

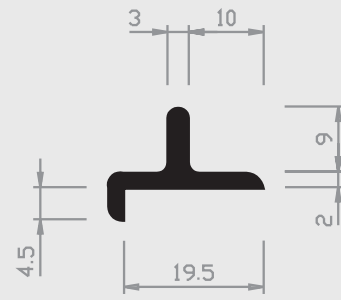

Nr. 16/29 H

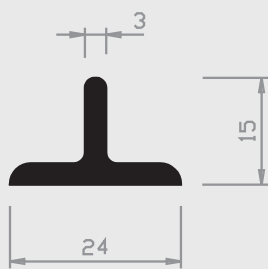

Nr. 12/29 HH

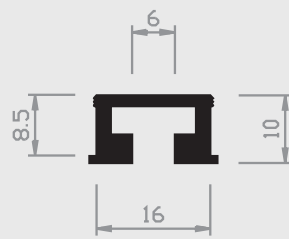

Nr. 17/31 H

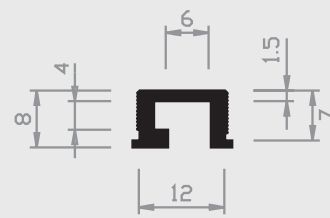

Nr. 17/32 H

■ = Hart PVC

■ = Weich PVC | HH = Halbhart PVC

□ = Andere Kunststoffe

07 | GLEITPROFILE

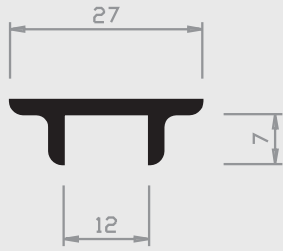

Nr. 10/59 H

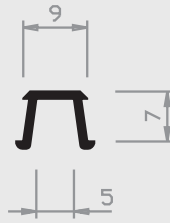

Nr. 18/27 H

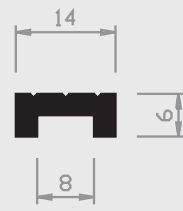

Nr. 15/28 H



Nr. 14/28 H

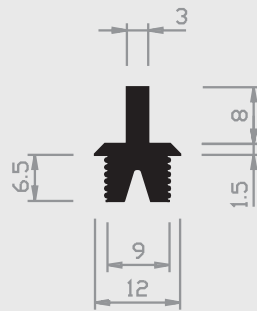

Nr. 18/28 H

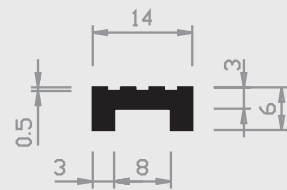

Nr. 17/28 H

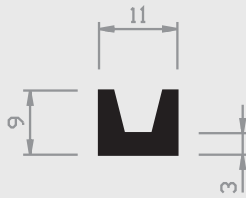

Nr. 44/36 H

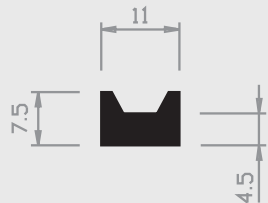

Nr. 45/36 H



Nr. 10/33 H



Nr. 10/32 H

= Hart PVC
 = Weich PVC | HH = Halbhart PVC
 = Andere Kunststoffe

07 | GLEITPROFILE

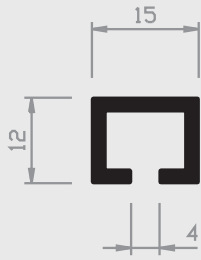

Nr. 8/33 H

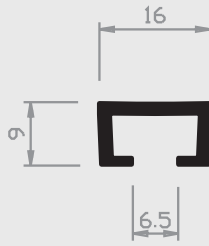

Nr. 11/33 H

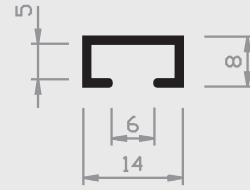

Nr. 12/33 H

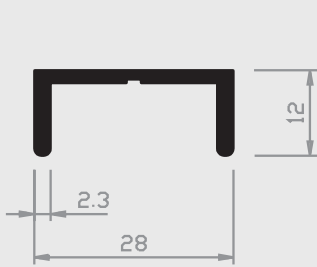

Nr. 5/24 H

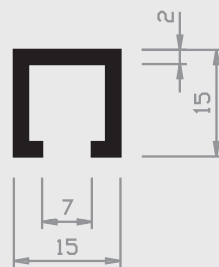

Nr. 14/33 H

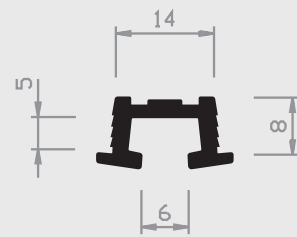

Nr. 18/33 H



Nr. 4/24 H

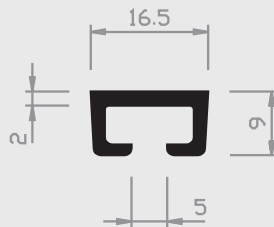

Nr. 13/33 H

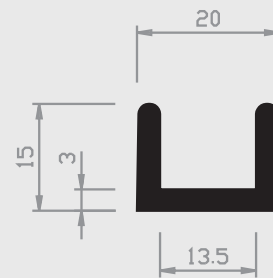

Nr. 17/61 H

= Hart PVC
 = Weich PVC | HH = Halbhart PVC
 = Andere Kunststoffe

07 | GLEITPROFILE

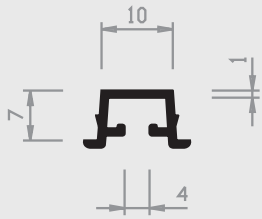

Nr. 10/45 H

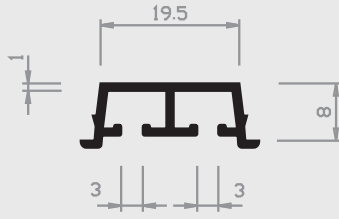

Nr. 10/46 H

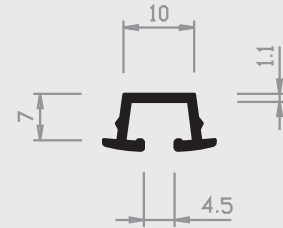

Nr. 14/45 H

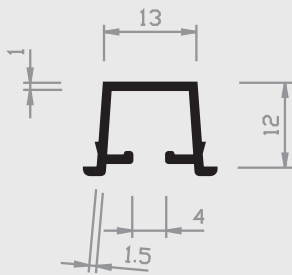

Nr. 16/45 H

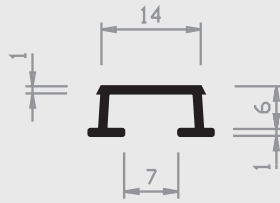

Nr. 17/45 H

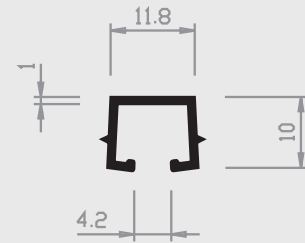

Nr. 22/45 H

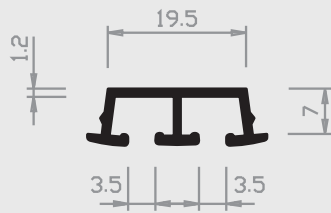

Nr. 15/45 H

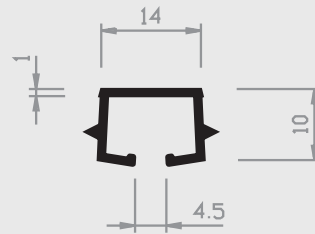

Nr. 23/45 H

= Hart PVC
 = Weich PVC | HH = Halbhart PVC
 = Andere Kunststoffe