

13 | VERBINDUNGSPROFILE

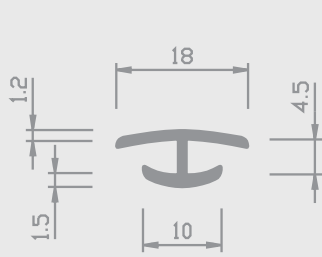

Nr. 10/72 W

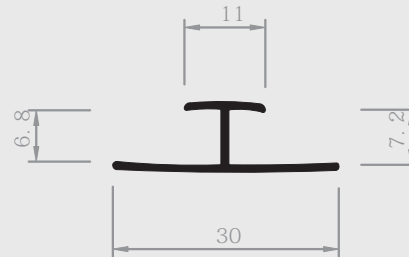

Nr. 13/73 H

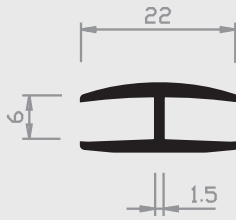

Nr. 11/72 H 6mm

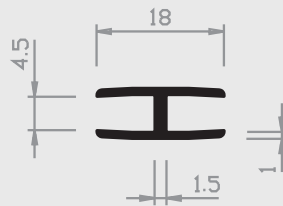

Nr. 13/72 H

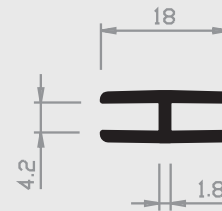

Nr. 11/73 H

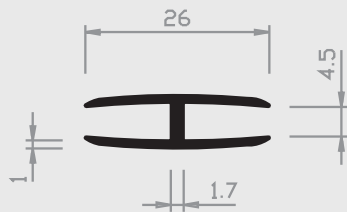

Nr. 17/72 H

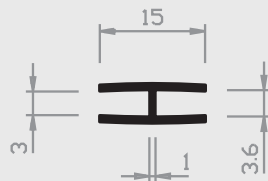

Nr. 9/72 H

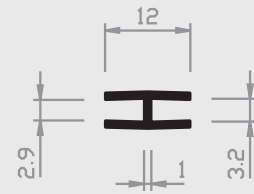

Nr. 9/72a H

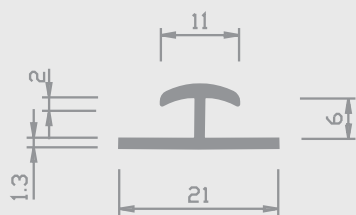

Nr. 14/72 W

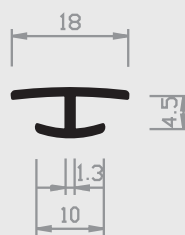

Nr. 12/72 H

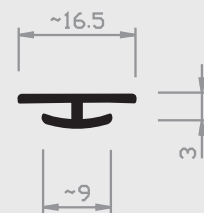

Nr. 12/72a H

= Hart PVC
 = Weich PVC | HH = Halbhart PVC
 = Andere Kunststoffe

13 | VERBINDUNGSPROFILE

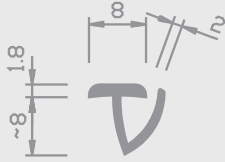

Nr. 10/70 W

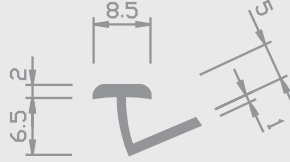

Nr. 14/70 W

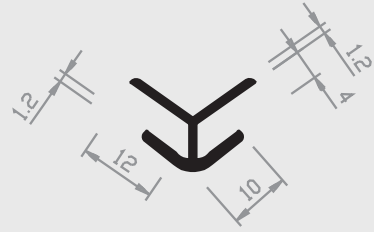

Nr. 12/71 H

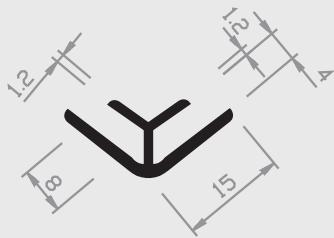

Nr. 12/70 H

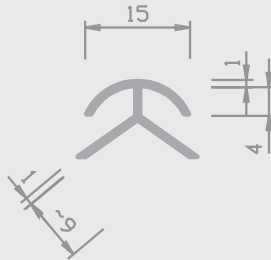

Nr. 10/71 W

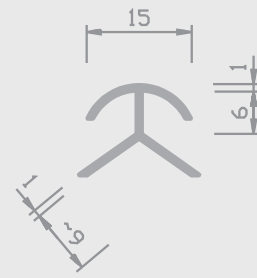

Nr. 14/71 W

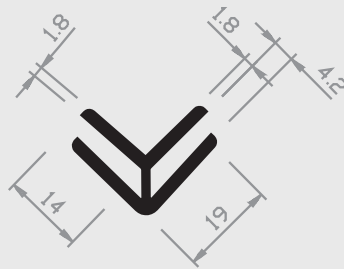

Nr. 13/71 H 4,2mm

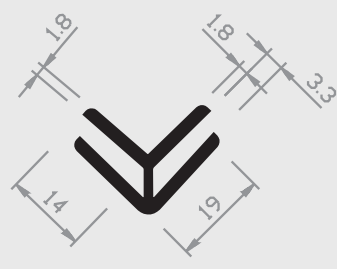

Nr. 13/71a H 3,3mm

■ = Hart PVC

■ = Weich PVC | HH = Halbhart PVC

□ = Andere Kunststoffe

13 | VERBINDUNGSPROFILE

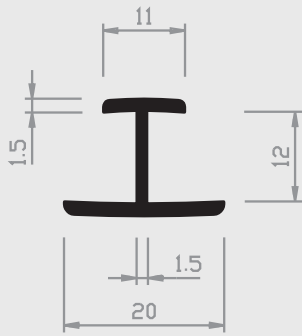

Nr. 19/59 H 12mm

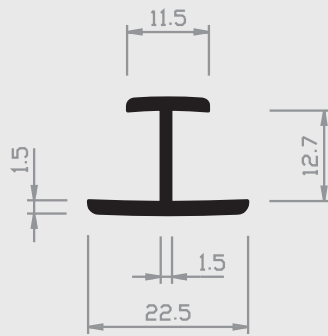

Nr. 19/59a H 12,7mm

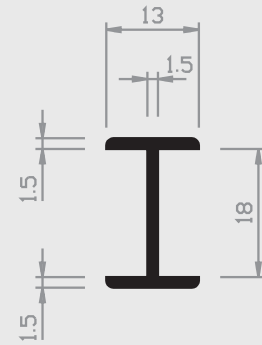

Nr. 19/60 H 18mm

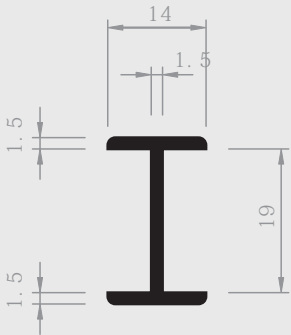

Nr. 19/60a H 19mm

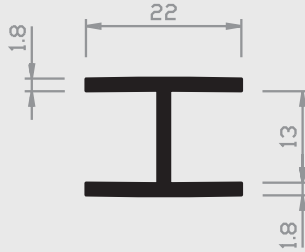

Nr. 19/61 H

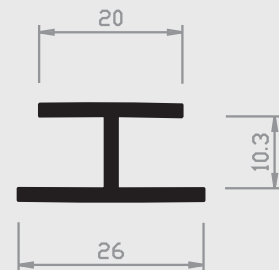

Nr. 19/62 H

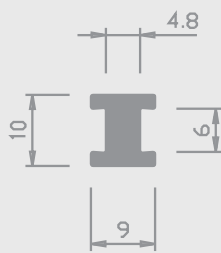

Nr. 8/37a HH

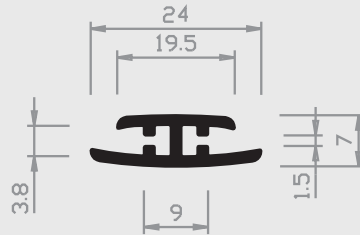

Nr. 19/72 H

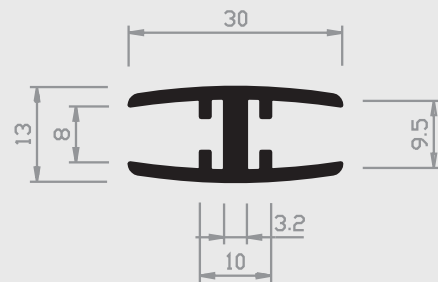

Nr. 22/72 H

= Hart PVC
 = Weich PVC | HH = Halbhart PVC
 = Andere Kunststoffe

13 | VERBINDUNGSPROFILE

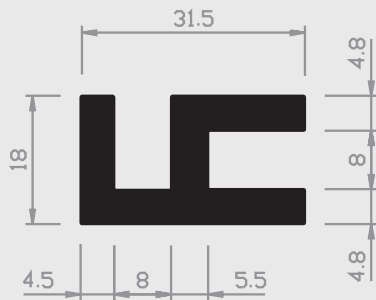

Nr. 19/20 H

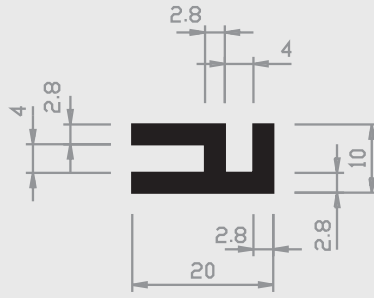

Nr. 19/21 H

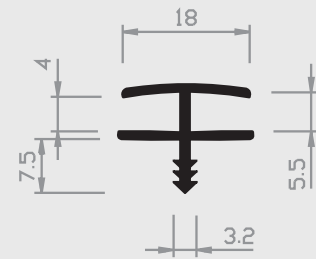

Nr. 25/59 H

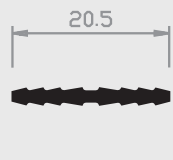

Nr. 15/39 H

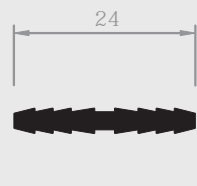

Nr. 15/39a H

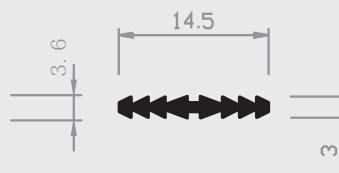

Nr. 15/39b H

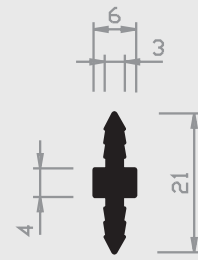

Nr. 17/39 H

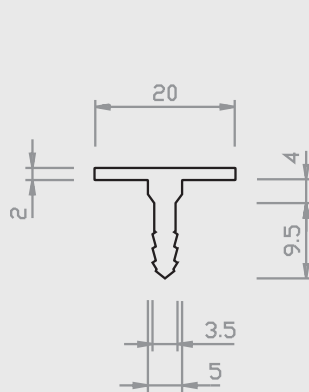

Nr. 25/60 ABS

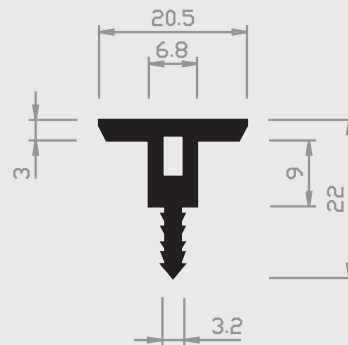

Nr. 25/58 H



Nr. 17/73 H

■ = Hart PVC ■ = Weich PVC | HH = Halbhart PVC □ = Andere Kunststoffe

13 | VERBINDUNGSPROFILE

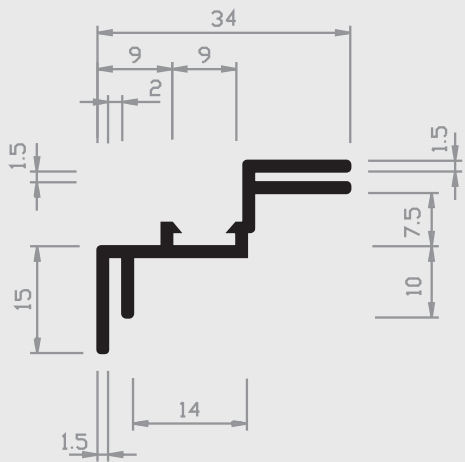

Nr. 17/19 H

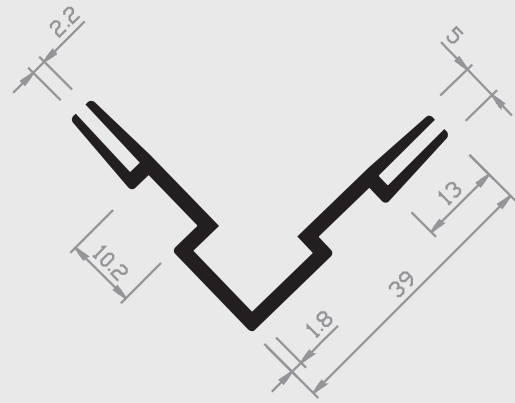

Nr. 19/18 H

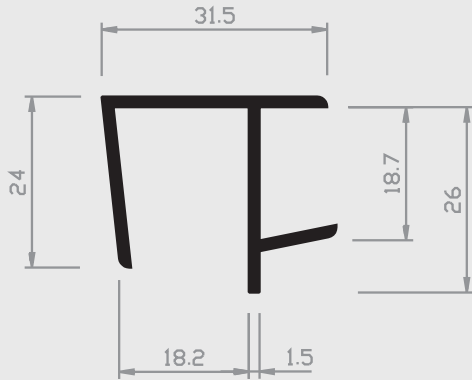

Nr. 15/69 H

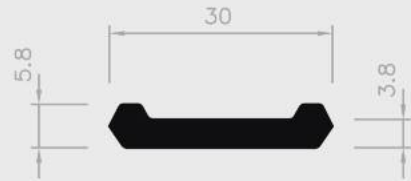

Nr. 29/39 H

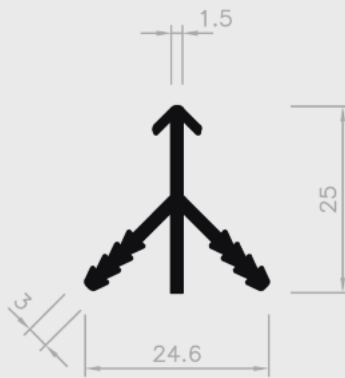

Nr. 20/71 H

= Hart PVC
 = Weich PVC | HH = Halbhart PVC
 = Andere Kunststoffe

13 | VERBINDUNGSPROFILE

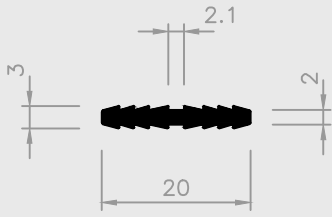

Nr. 15/39C H

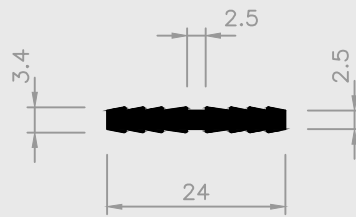

Nr. 15/39A H



Nr. 15/39F H

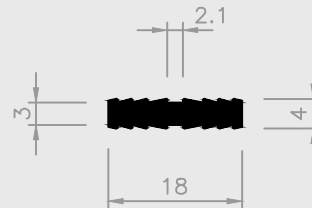

Nr. 15/39E H

■ = Hart PVC ■ = Weich PVC | HH = Halbhart PVC □ = Andere Kunststoffe