

08 | EINFASSPROFILE



Nr. 9/34 W



Nr. 9/34a W

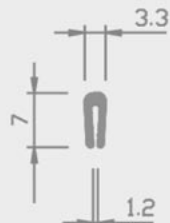

Nr. 10/34 W



Nr. 9/35 W



Nr. 23/35 H



Nr. 13/35 H

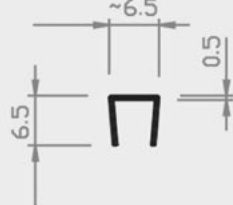

Nr. 22/35 H



Nr. 8/35 H



Nr. 28/35 H



Nr. 7/33 W



Nr. 7/36 W



Nr. 7/35 W

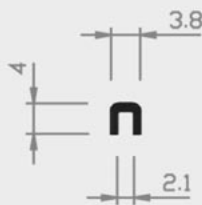

Nr. 4/35 H



Nr. 6/35 H

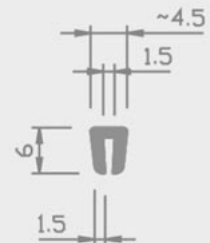

Nr. 10/35 W

■ = Hart PVC

■ = Weich PVC | HH = Halbhart PVC

□ = Andere Kunststoffe

08 | EINFASSPROFILE



Nr. 7/34 W

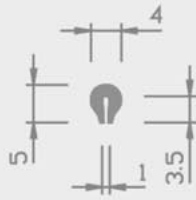

Nr. 11/34 W

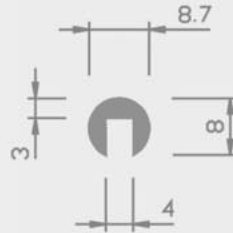

Nr. 14/34 HH

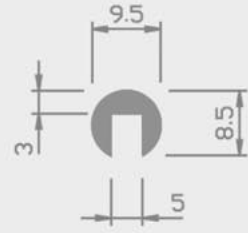

Nr. 14/34a HH

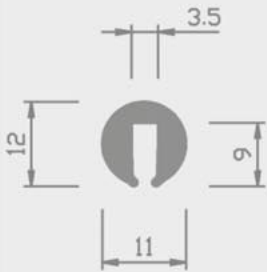

Nr. 52/28 W

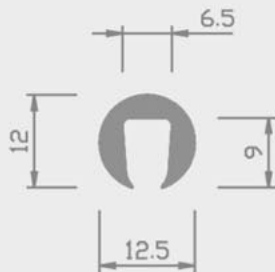

Nr. 53/28 W

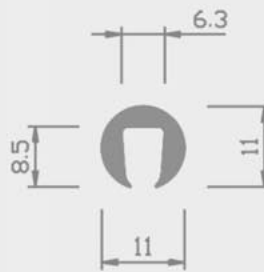

Nr. 53/28a W

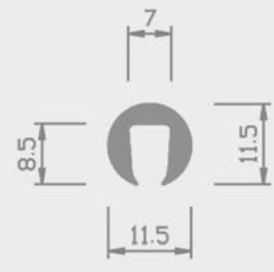

Nr. 55/28a W

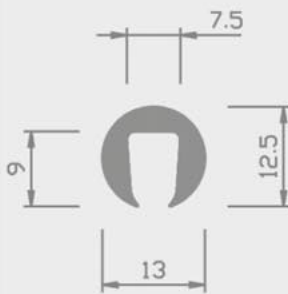

Nr. 55/28 W

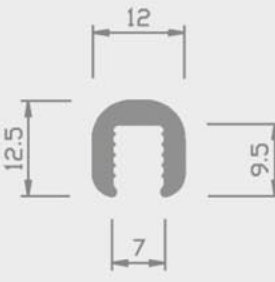

Nr. 20/34 HH

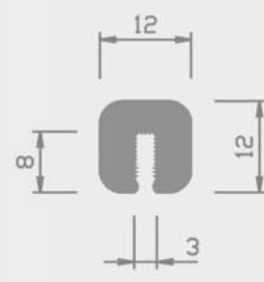

Nr. 51/28 W

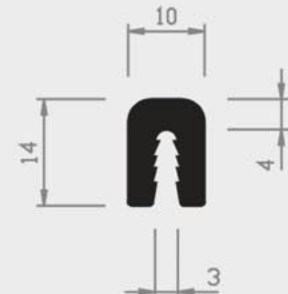

Nr. 15/35 H

= Hart PVC
 = Weich PVC | HH = Halbhart PVC
 = Andere Kunststoffe

08 | EINFASSPROFILE

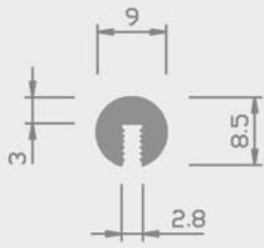

Nr. 16/34 HH

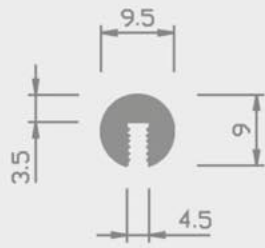

Nr. 16/35 HH

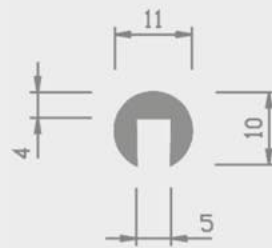

Nr. 19/34 HH

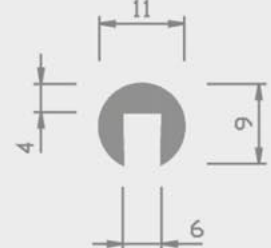

Nr. 13/34 H

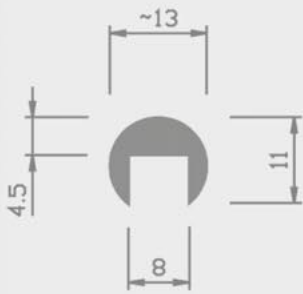

Nr. 12/34 HH

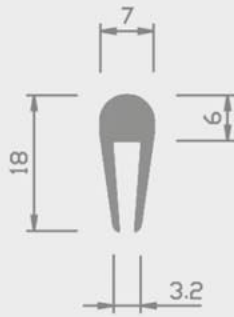

Nr. 15/34 W

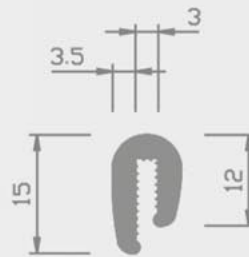

Nr. 51/30 W

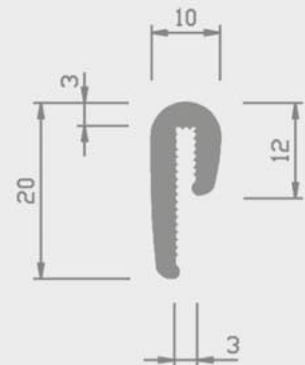

Nr. 51/29 W

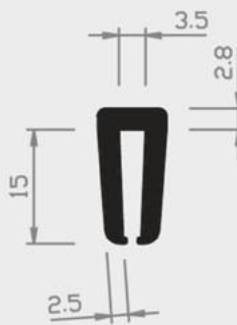

Nr. 27/34 H

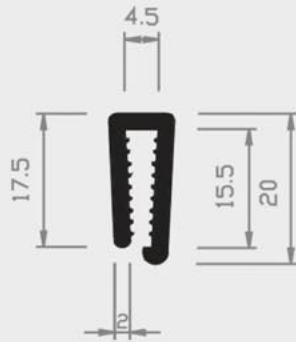

Nr. 55/24 H

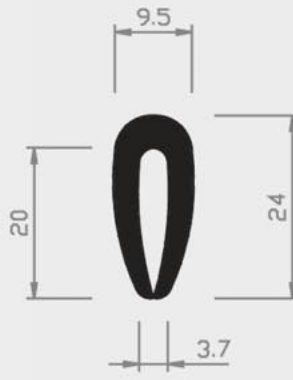

Nr. 17/34 H

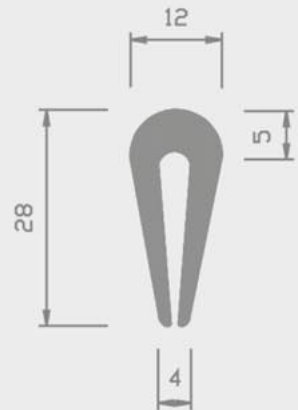

Nr. 18/34 W

= Hart PVC
 = Weich PVC | HH = Halbhart PVC
 = Andere Kunststoffe

08 | EINFASSPROFILE



Nr. 51/15a HH



Nr. 51/15 HH



Nr. 53/15 HH



Nr. 52/15 HH

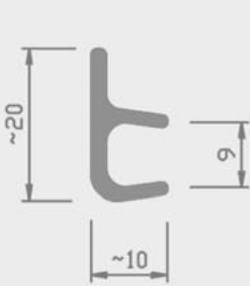

Nr. 52/16 HH



Nr. 52/17 W



Nr. 52/18 W

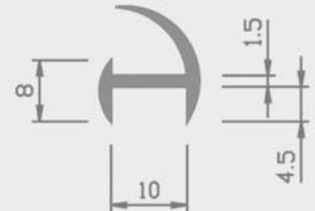

Nr. 54/15 HH

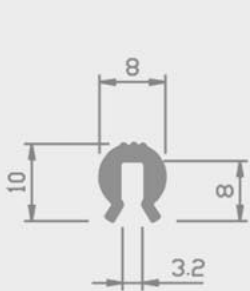

Nr. 50/28 HH

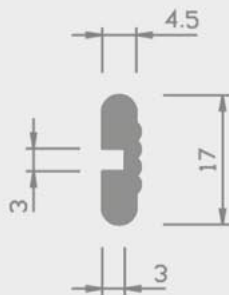

Nr. 8/34 HH

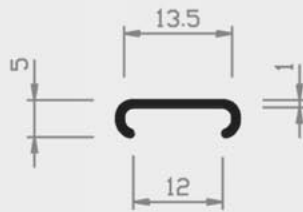

Nr. 5/38 H

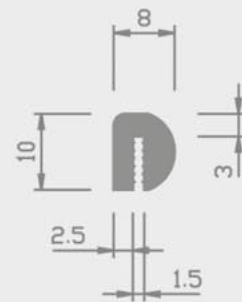

Nr. 22/34 W

= Hart PVC
 = Weich PVC | HH = Halbhart PVC
 = Andere Kunststoffe

08 | EINFASSPROFILE



Nr. 8/35a H

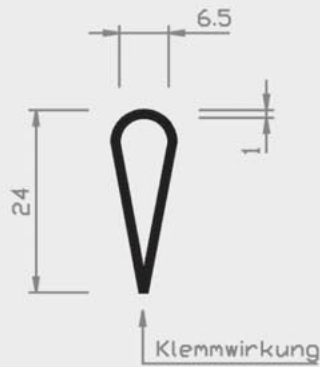

Nr. 31/35 H

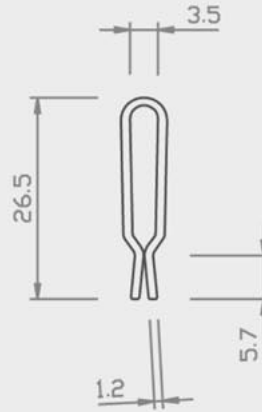

Nr. 26/35a PP

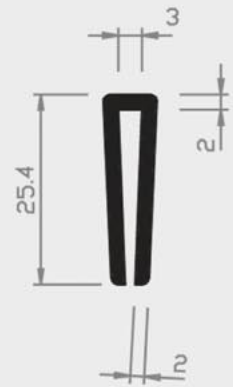

Nr. 25/34 H



Nr. 2/35 W



Nr. 18/35b H



Nr. 18/35 H
Nr. 18/35a H

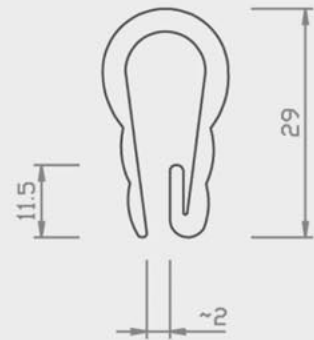

Nr. 61/7 PE

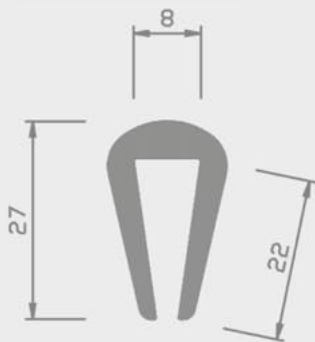

Nr. 26/34 W

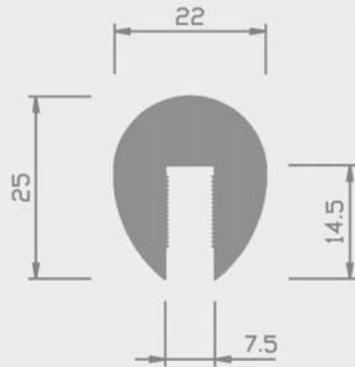

Nr. 24/34 W

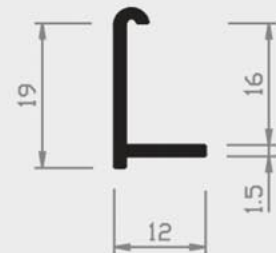

Nr. 10/69 H

■ = Hart PVC

■ = Weich PVC | HH = Halbhart PVC

□ = Andere Kunststoffe

08 | EINFASSPROFILE

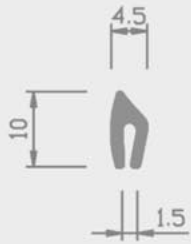

Nr. 7/38 W

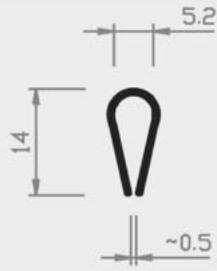

Nr. 29/35 H



Nr. 20/35 HH

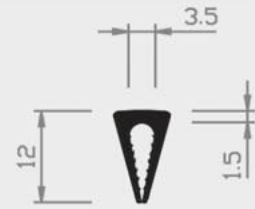

Nr. 12/35 H

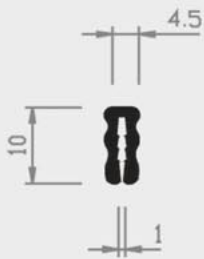

Nr. 5/34 H

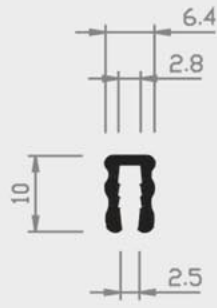

Nr. 5/35 H



Nr. 7/37 W

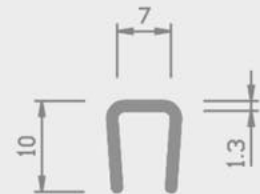

Nr. 37/36 HH

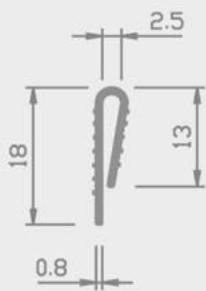

Nr. 17/35 W

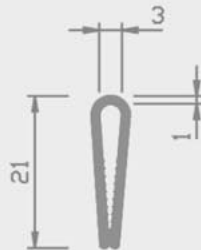

Nr. 19/35 HH

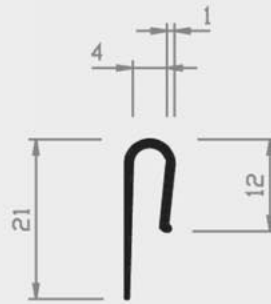

Nr. 18/31 H

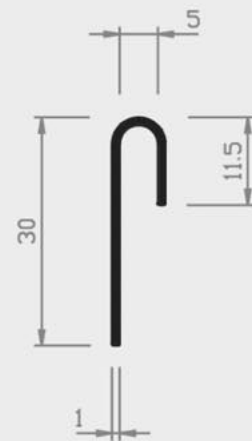

Nr. 18/32 H

= Hart PVC
 = Weich PVC | HH = Halbhart PVC
 = Andere Kunststoffe

08 | EINFASSPROFILE

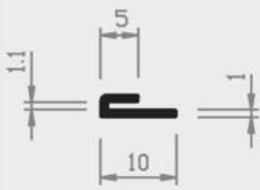

Nr. 29/32 H



Nr. 4/73 W

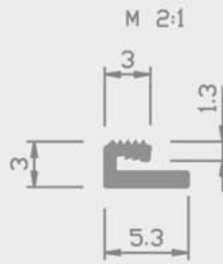

Nr. 5/73 HH

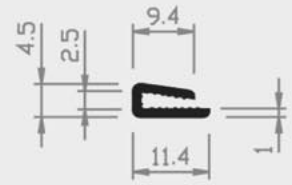

Nr. 29/34 H



Nr. 10/64 H

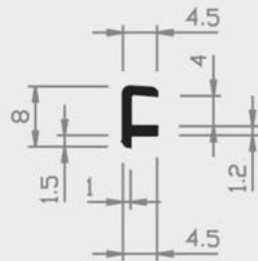

Nr. 12/64 H

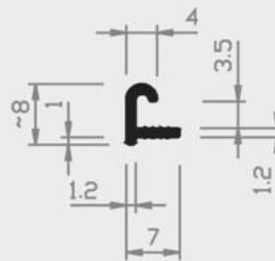

Nr. 10/65 H

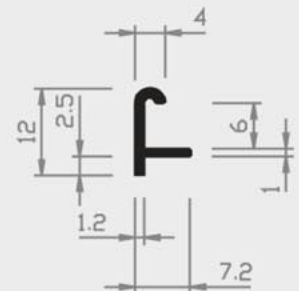

Nr. 10/66 H

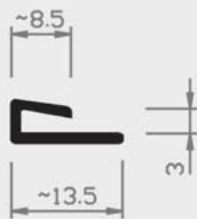

Nr. 12/73a H

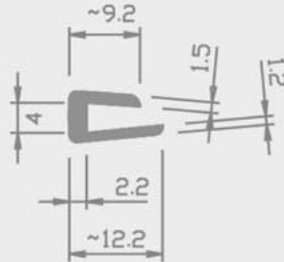

Nr. 21/34 W



Nr. 14/35 H

■ = Hart PVC

■ = Weich PVC | HH = Halbhart PVC

□ = Andere Kunststoffe

08 | EINFASSPROFILE

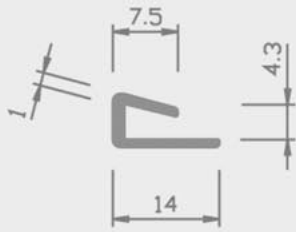

Nr. 10/73 W
od. 12/73 H

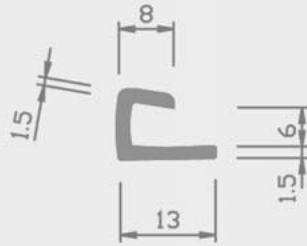

Nr. 10/76 W
od. 10/76 H

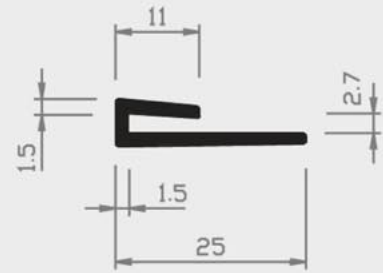

Nr. 14/73 H

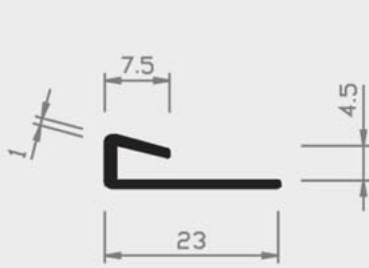

Nr. 10/73a H

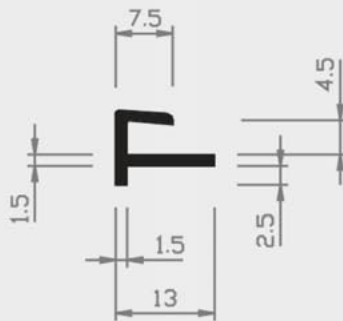

Nr. 10/74 H

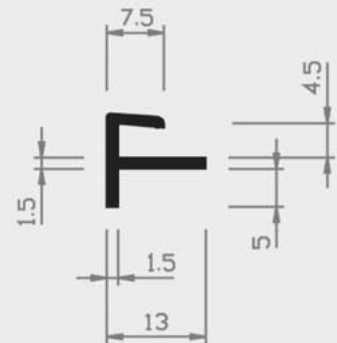

Nr. 10/75 H

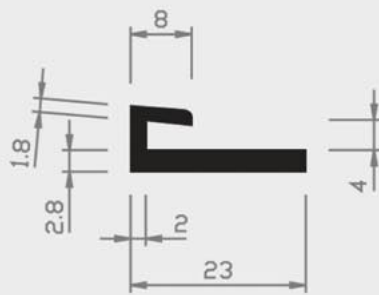

Nr. 15/73 H

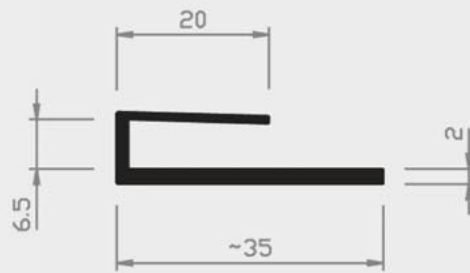

Nr. 30/35 H

■ = Hart PVC ■ = Weich PVC | HH = Halbhart PVC □ = Andere Kunststoffe

08 | EINFASSPROFILE

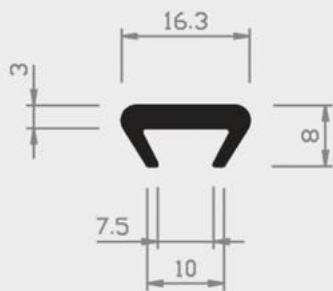

Nr. 27/35 H

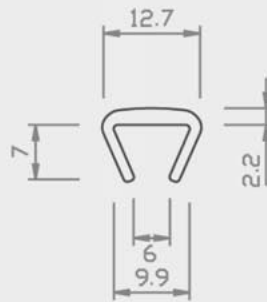

Nr. 51/16 PP

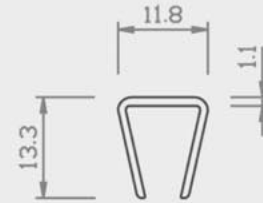

Nr. 2/36 TPE

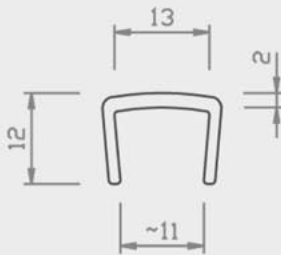

Nr. 51/17 PP

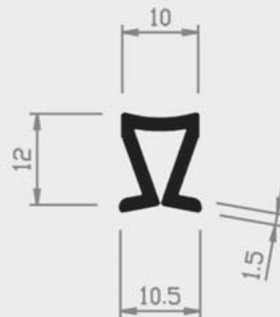

Nr. 21/35 H

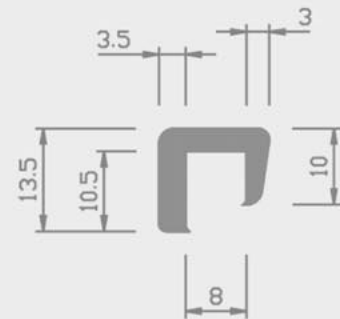

Nr. 23/34 W

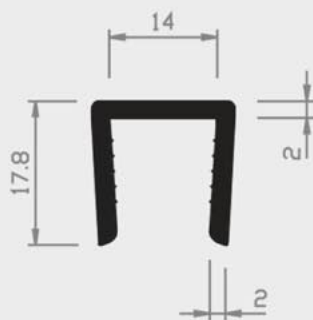

Nr. 24/35 H

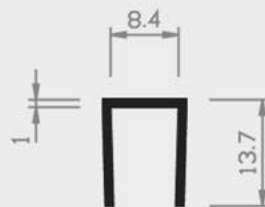

Nr. 6/34 H

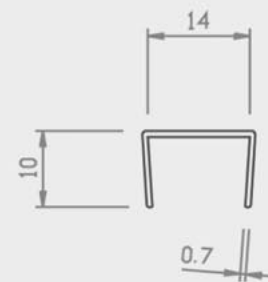

Nr. 53/36 ABS

= Hart PVC
 = Weich PVC | HH = Halbhart PVC
 = Andere Kunststoffe

08 | EINFASSPROFILE

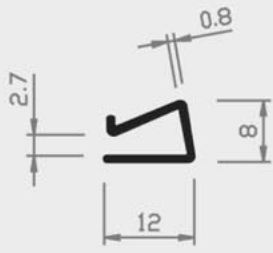

Nr. 3/34 H

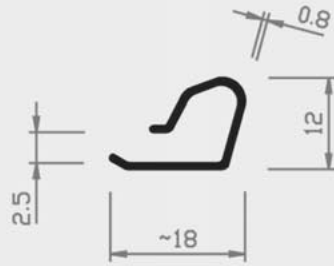

Nr. 3/35 H

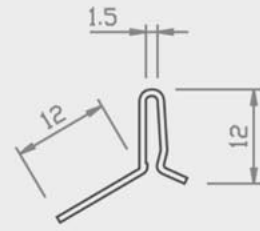

Nr. 18/38 PP

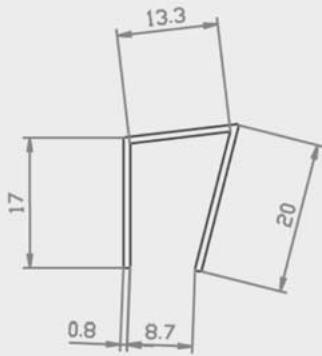

Nr. 52/36a ABS

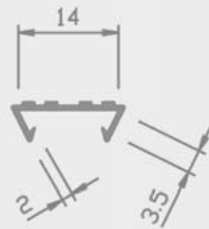

Nr. 11/74 W



Nr. 12/74
H

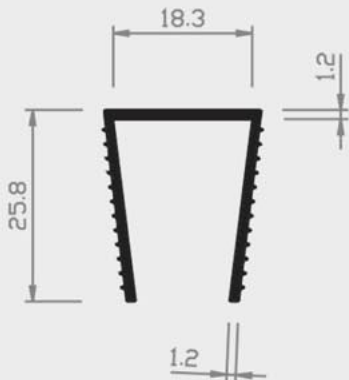

Nr. 6/36 H

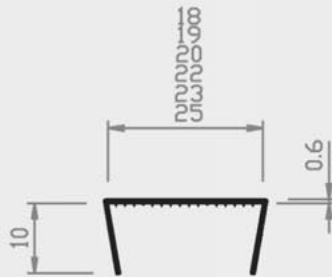

Nr. 47/36 H

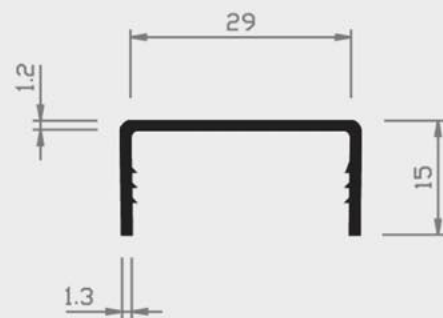

Nr. 20/65 H

= Hart PVC
 = Weich PVC | HH = Halbhart PVC
 = Andere Kunststoffe

08 | EINFASSPROFILE

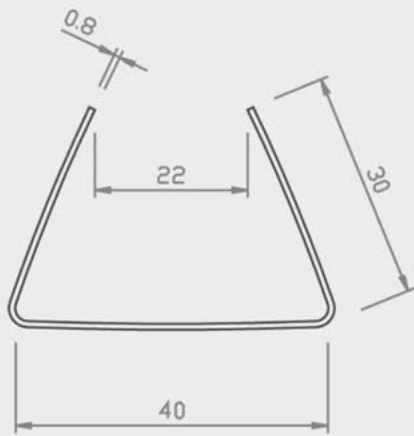

Nr. 57/36 ABS

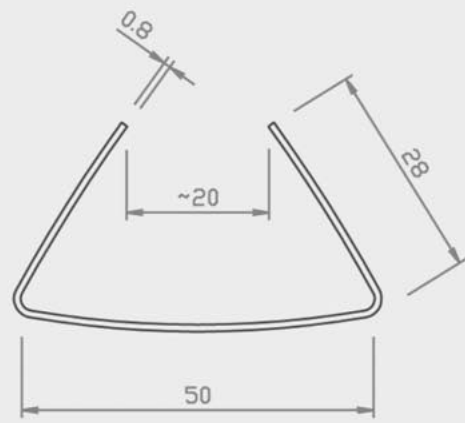

Nr. 58/36 ABS

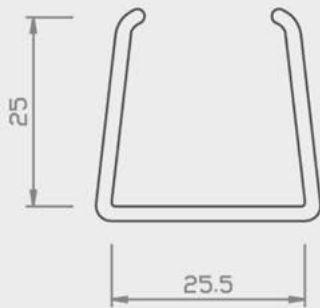

Nr. 4/33 HDPE

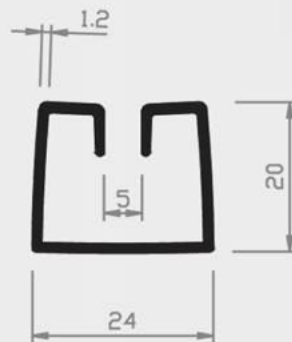

Nr. 26/96 H

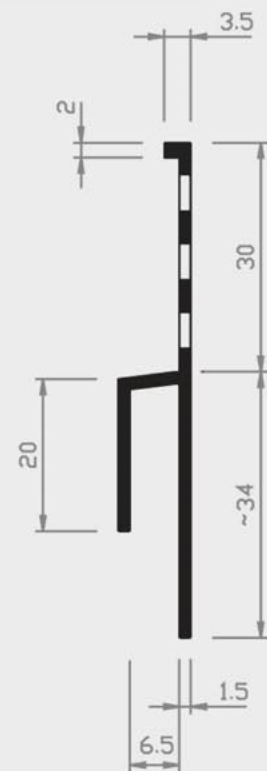

Nr. 30/34 H



Nr. 9/60 W

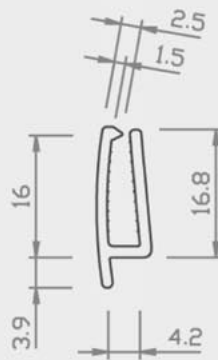

Nr. 9/59 PE

= Hart PVC
 = Weich PVC | HH = Halbhart PVC
 = Andere Kunststoffe

08 | EINFASSPROFILE

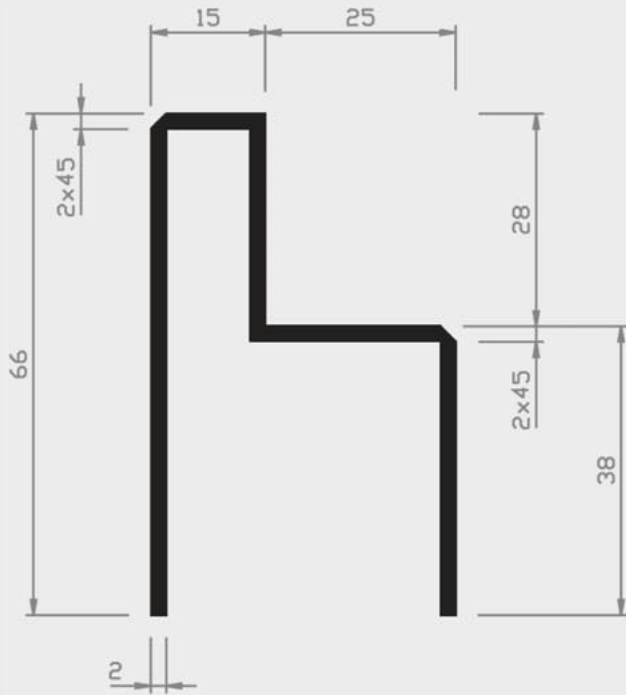

Nr. 20/66 H

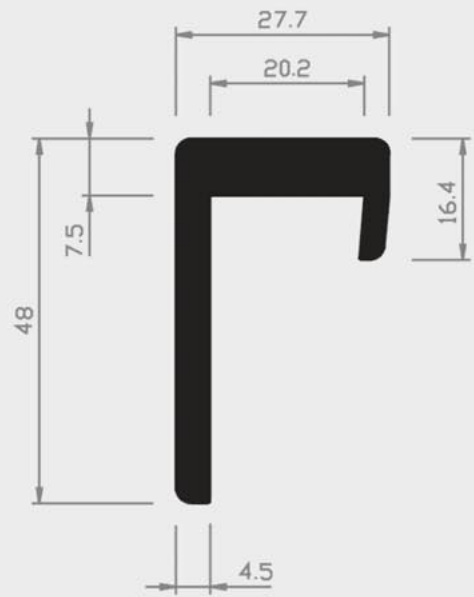

Nr. 66/63 H

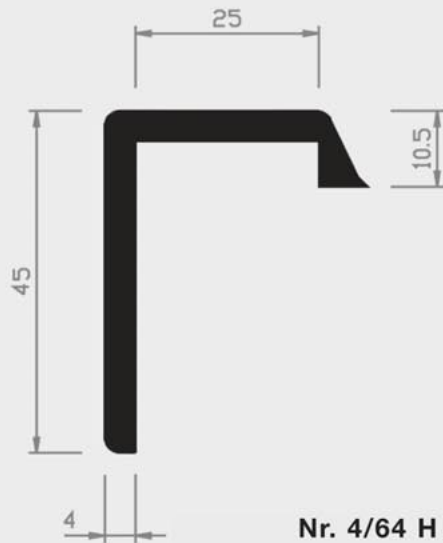

Nr. 4/64 H

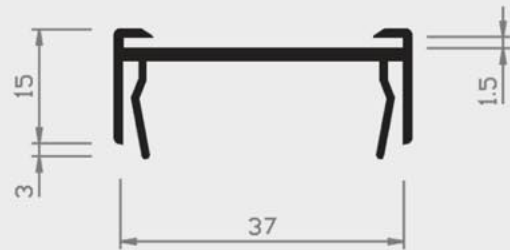

Nr. 20/62 H

= Hart PVC
 = Weich PVC | HH = Halbhart PVC
 = Andere Kunststoffe

08 | EINFASSPROFILE

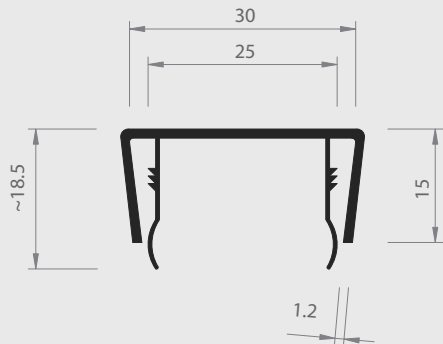

Nr.20/64 H

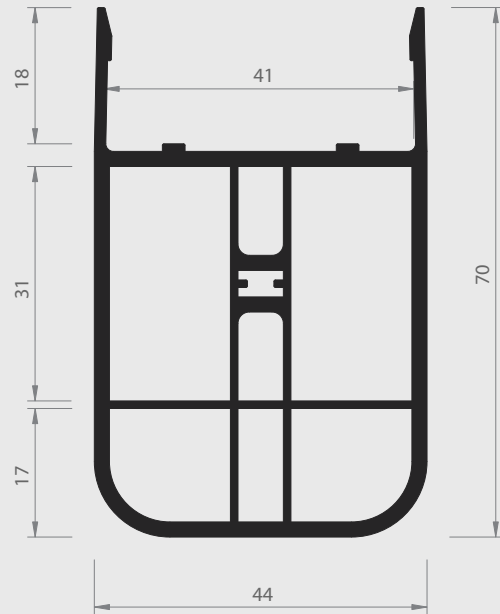

Nr.08/56 H

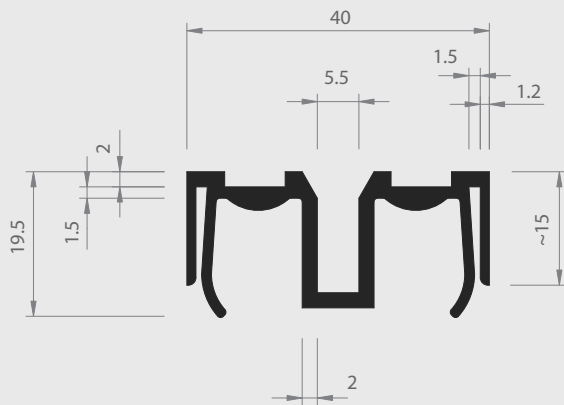

Nr.20/69 H

= Hart PVC
 = Weich PVC | HH = Halbhart PVC
 = Andere Kunststoffe

08 | EINFASSPROFILE

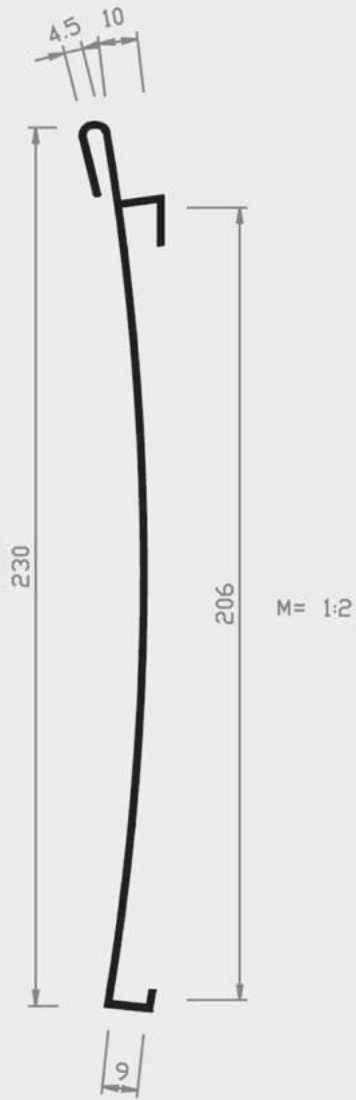

Nr. 6/25 H

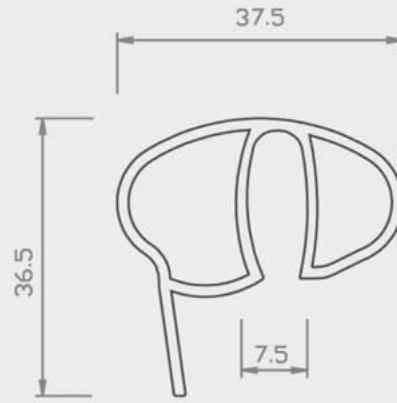

Nr. 6/26 HDPE



Nr. 6/27 H

= Hart PVC
 = Weich PVC | HH = Halbhart PVC
 = Andere Kunststoffe

08 | EINFASSPROFILE

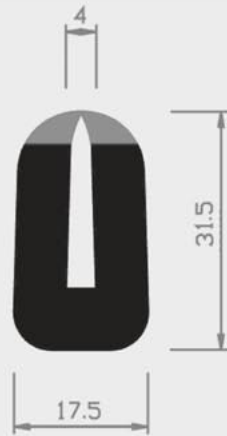

Nr. 31/34 H+W

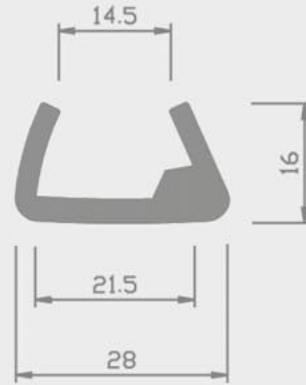

Nr. 21/17 W



Nr. 33/35 H



Nr. 32/35 H

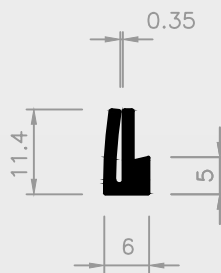

Nr. 36/34 H

= Hart PVC
 = Weich PVC | HH = Halbhart PVC
 = Andere Kunststoffe

08 | EINFASSPROFILE

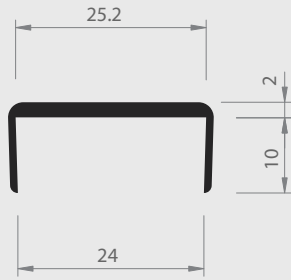

Nr. 21/27 H

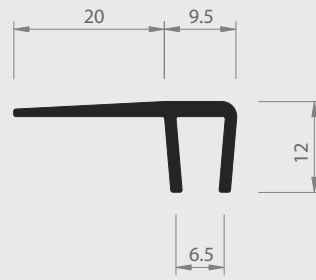

Nr. 29/58 H

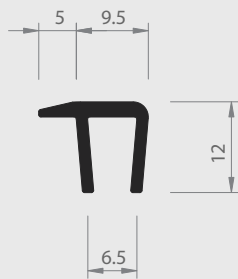

Nr. 29/58a H

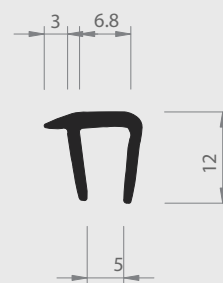

Nr. 29/58b H

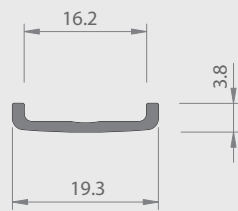

Nr. 16/23 HH

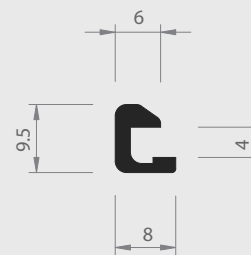

Nr. 09/61 H

= Hart PVC
 = Weich PVC | HH = Halbhart PVC
 = Andere Kunststoffe

08 | EINFASSPROFILE



Nr. 40/45 H

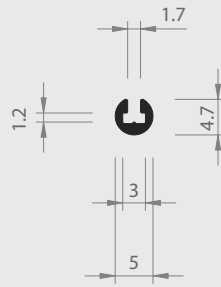

Nr. 54/33 H

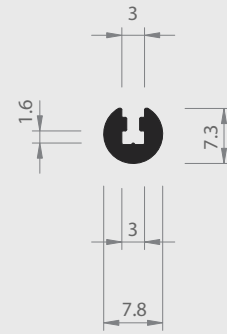

Nr. 54/34 H

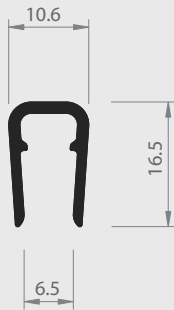

Nr. 01/36 H

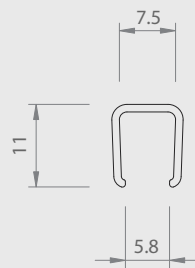

Nr. 23/65 PC

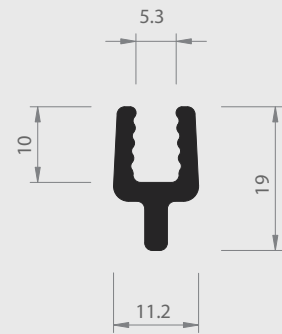

Nr. 23/48 H

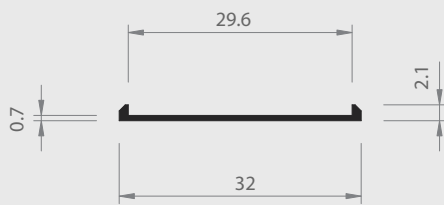

Nr. 28/25 H



Nr. 28/26 H

= Hart PVC
 = Weich PVC | HH = Halbhart PVC
 = Andere Kunststoffe

08 | EINFASSPROFILE

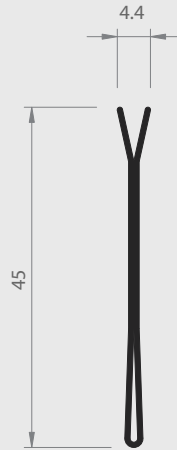

Nr. 20/31 H

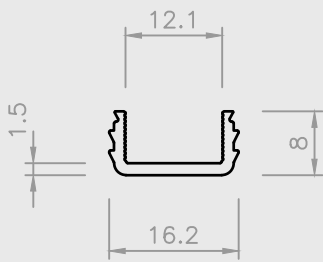

Nr. 51/41 TPU

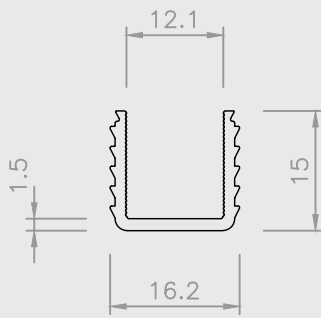

Nr. 51/42 TPU

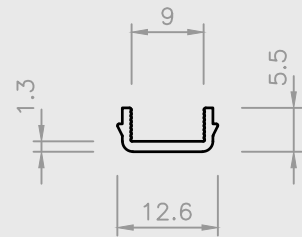

Nr. 51/43 TPU

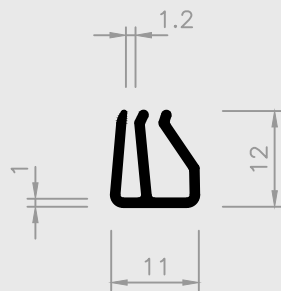

Nr. 8/57 H

■ = Hart PVC

■ = Weich PVC | HH = Halbhart PVC

□ = Andere Kunststoffe